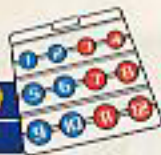

POWER PAD REQUIREDNintendo ENTERTAINMENT SYSTEM[®]

Dance Aerobics

Hop, skip and jump your way into shape!

INSTRUCTION BOOKLET**Nintendo[®]**

This official seal is your assurance that Nintendo has reviewed this product and that it has met our standards for excellence in workmanship, reliability and entertainment value. Always look for this seal when buying games and accessories to ensure complete compatibility with your Nintendo Entertainment System.



Thank you for selecting the Nintendo Entertainment System® Dance Aerobics™ Pak. This game requires the Power Pad™ attachment.

Please read this instruction booklet to ensure proper handling of your new game, and then save the booklet for future reference.

PRECAUTIONS

- 1) This is a high precision game. It should not be stored in places that are very hot or cold. Never hit or drop it. Do not take it apart.
- 2) Avoid touching the connectors, do not get them wet or dirty. Doing so may damage the game.
- 3) Do not clean with benzene, paint thinner, alcohol or other such solvents.

Note:

In the interest of product improvement, Nintendo Entertainment System specifications and design are subject to change without prior notice. This game has been programmed to take advantage of the full screen. Some older model TV's have rounded screens and may block out a portion of the image.

SAFETY PRECAUTIONS

⚠ WARNING ⚠

Persons with heart, respiratory, back and joint problems, high blood pressure or under a physician's direction to restrict activity *should not use the Power Pad without a physician's advice*. Pregnant women should not use the Power Pad. Serious personal injury can result.

⚠ CAUTION ⚠

- Do not wear shoes!! Keep all sharp objects away from the Power Pad at all times.
- Do not use the Power Pad outside or near sources of heat or moisture.
- Do not use the Power Pad on any soft, thickly padded surface such as a couch or lawn. You could stretch or break the internal mechanism as well as cause possible personal injury.
- Make sure the Control Deck power is OFF when changing any Game Pak or making a connection from the Power Pad. Connecting it with the power on could damage the Nintendo Entertainment System. Do not stand on the Power Pad while making a connection.
- When unplugging the Power Pad connector from the Control Deck, always hold the connector itself, not the cord. Do not touch the terminals or wet them with water. Personal injury could result.
- All users should do several minutes of warm-up exercises before starting to play games on the Power Pad.
- Select an area to use the Power Pad where you will not be in the way of other people or objects in case of falls. Do not position the television set where you may hit it if you fall. Failure to read and comply with the instructions, including these safety precautions may result in personal injury to you and/or damage to the Power Pad. Nintendo of America Inc. assumes no responsibility, obligation, or liability for injuries sustained due to such failure.

CONTENTS

1. Welcome to Dance Aerobics	5
2. The Aerobic Studio Curriculum	6
3. How to connect and operate the Power Pad	7
4. Lesson time	9
5. Getting Started	10
6. Dance Aerobics	11
7. How to input your Pass Stamp	15
8. Pad Antics	16
9. Aerobic Studios	19

INTRODUCTION

This game is designed for use with the Power Pad. It gives you the thrill of real Aerobics as you use your body energetically on the Power Pad. With Dance Aerobics, shape up using the "B" side of the Power Pad.

REMEMBER!!!!!!!

Warm up before playing Dance Aerobics.
Don't over do it! We suggest a maximum of one hour a day.
When playing, don't strain yourself...relax and enjoy!

1. WELCOME TO DANCE AEROBICS

In Dance Aerobics, follow what the Instructor does and says. Progress through all 8 classes in the exercise studio, from the introductory class right up to the most advanced level. Your room will change into an aerobic studio whenever you want it to. You can enjoy a work out with your family, friends, or by yourself. But remember, it's important to work out at a pace that's just right for you.



From the Instructors

What is "Aerobic Exercise"?

"Aerobics" is a type of exercise for improving your stamina. It aims at building up your body so your heart and lung functions can efficiently carry oxygen throughout your body. Stamina, not muscle power is important for your body health. This is the basic philosophy behind aerobics.

2. THE AEROBIC STUDIO CURRICULUM

Dance Aerobics

Introductory Classes	Beginner Classes	Intermediate Classes	Advanced Classes
1 & 2	3 & 4	5 & 6	7 & 8

Pass Stamp

The code entry screen which allows you to begin at the higher levels in Dance Aerobics.

Pad Antics

- Tune Up
- Mat Melodies
- Ditto

Aerobic Studios

Studio	Studio	Studio	Studio
5	10	15	20



3. HOW TO CONNECT AND OPERATE THE POWER PAD

Use Side B of the Power Pad with this Game Pak. Do not use Side A.

HOW TO CONNECT THE POWER PAD TO YOUR NINTENDO ENTERTAINMENT SYSTEM CONTROL DECK.

To adjust the television screen when connecting the Control Deck to your television, carefully read the Control Deck and television instructions.



1. Turn the Control Deck Power Switch to OFF. Plug the Control Deck Controller Connector into the No.1 socket on the front of the Control Deck.



2. Plug the Power Pad Connector into the No.2 socket on the front of the Control Deck.



3. Insert the Game Pak into the Control Deck. Open up the Power Pad completely, then turn on the Power Switch on the Control Deck.

Power Pad Parts

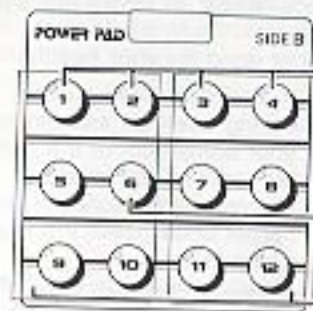

① ② ③ ④ choose selections on the game menus.

⑤ starts the game

① ← ② for entire game once started.

Controller

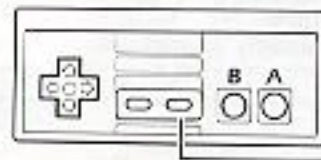

Start Button
Press the Start Button to pause the action during play.

4. LESSON TIME

1. Before starting Dance Aerobics, warm up with a few light stretching and jumping exercises.
Caution: Sudden exercise is not good for your health.



2. If the Power Pad moves during exercise and hinders your enjoyment of the game, we recommend laying a commercially available vinyl carpet underneath the Power Pad. This will also dampen noise.
Masking tape can also be used to hold the Power Pad down. Avoid using heavy manufactured tape, such as "Duct Tape" because it can remove the texture from the Power Pad.

Special Precautions

1. Limit play to a maximum of one hour per day.
2. Excessive exercise can be harmful.
3. Consult your physician if you classify yourself as:
 - Being pregnant
 - Under medication
 - Having heart problems
 - Having physical disabilities



5. GETTING STARTED

Press Start on the Controller or step on number ⑥ on the Power Pad. In either case the Main Menu Select Screen will appear.



Main Menu Select Screen ▶

When you step on ① ② ③ or ④ of the Power Pad, that particular game or game menu will appear on the screen.

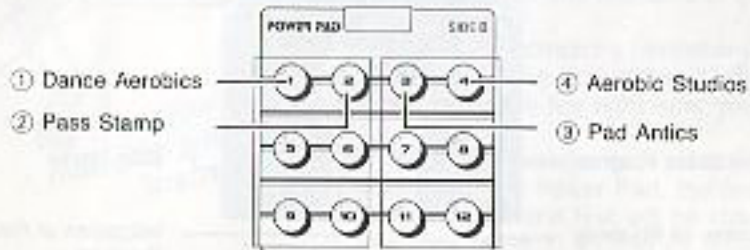

6. DANCE AEROBICS

Follow your Instructor's movements and aerobicise on the Power Pad. There are eight different classes, each more challenging than the last. For every mistake you make in the timing of your steps or where you move on the Power Pad, the number of coins will decrease. Once you have lost all of your coins you can not afford to make a mistake. If you do, the class is over and you will not get the Pass Stamp to the next level!

Now watch your Instructor carefully and start exercising.

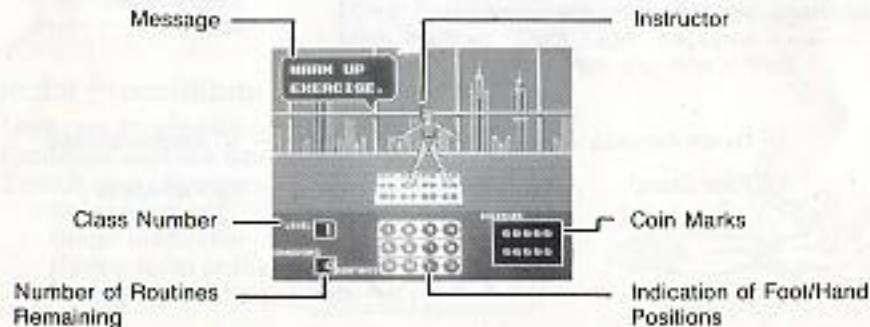

First of all, the Instructor will show you a series of steps or "Routine". Here, the coins will not disappear if you make a mistake. Learn the steps while matching your movements to the Instructor's.



Let's practice together!

Try not to make any mistakes in your movements!
Follow your Instructor's movements as if you were looking in a mirror. If your Instructor raises her right arm, you raise your left arm.
When you're exercising in a seated position on the Power Pad, the position of your hands and feet will be checked. You may sit on ⑥ & ⑦ or ⑩ & ⑪.

Introductory Classes 1 & 2

Beginner Classes 3 & 4

The Instructor will give the message "WATCH THE WAY I MOVE" to allow you to practice the routines. When the message "FOLLOW ME" appears, judging will begin. If the message "RELAX AND ENJOY" appears, the judges have determined that incorrect moves are being made.

Intermediate Classes 5 & 6

In these classes, you exercise together with your Instructor without practicing. You're not judged for the first eight beats of the class.

Advanced Classes 7 & 8

These are just like the intermediate classes, but, you are not judged for the first four beats of the class. If you complete the final class (8) you will be crowned An Aerobics Superstar!



YOU'LL BE CROWNED AN AEROBICS SUPERSTAR!



Once crowned, press the Reset Button and the Routines will change to make it even more of a challenge. Each time you make the mistake of moving out of time or misplacing your hands or feet, you lose a coin. Once you lose all the coins your class is over. So watch carefully what the Instructor's doing!



PASS STAMP NUMBER

The next time you work out with Dance Aerobics, you can start from the next class if you input your Pass Stamp Number. Read the next page for details on how to input the Pass Stamp.



7. HOW TO INPUT YOUR PASS STAMP

For each class successfully completed in Dance Aerobics you will be shown a number. This number is your Pass Stamp. You can advance to the next higher level class using this number along with Pass Stamps from earlier levels (if any). To input your Pass Stamp first select "Pass Stamp" on the Menu Selection Screen.

It looks like this!



Pass Stamp Input Screen ▶

The Pass Stamp screen will appear. Use the corresponding numbers on the Power Pad to enter your Pass Stamp(s). Enter your Pass Stamps in the order received. Once your Pass Stamp(s) is entered, press number ⑥ on the Power Pad to start your class.

8. PAD ANTICS

If you step on number ③ of the Dance Aerobics Menu Selection Screen, the Pad Antics Menu Screen will appear. You can choose Tune Up, Mat Melodies or Ditto.



Pad Antics Menu Screen ▶

(TUNE UP)

In this game you make music with the Power Pad. The screen shows you the Power Pad, and where the notes are.

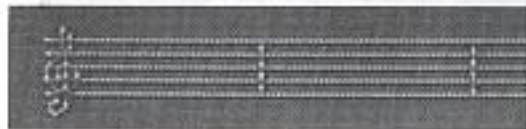

When you step on a note on the Power Pad (except ⑥ & ⑦), it will show up on the music score above.

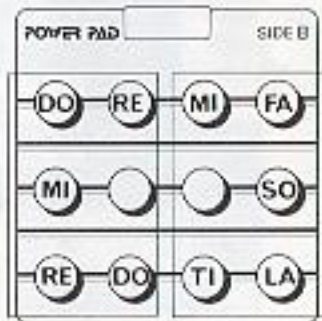

(MAT MELODIES)

Mat Melodies is similar to Tune Up but in this case you play along with the Mat Melody tune. Move your feet around the Power Pad just as the green dots move on the screen. Be aware, your errors are being counted and if you make too many, your game will end.



(DITTO)

In this segment of Pad Antics you are challenged to match the computer's green feet and hands. It's not easy. The positions for placing your hands and feet will appear one after the other. Any body position is fine, but you have to put your hands and feet on the points indicated.



The quicker you are at placing your hands and feet on the designated points on Power Pad, the higher your score. If you score more than 80 points, the pace gets faster.



9. AEROBIC STUDIOS

There are four different Aerobic Studios. Studio 5, 10, 15, 20.



Aerobic Studios Menu
Screen ▶

Using ① ② ③ ④ you can select a 5, 10, 15 or 20 minute workout.

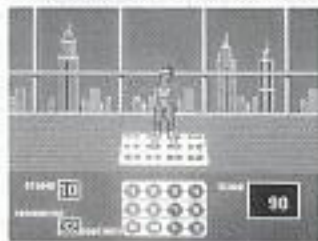

Your score for each studio workout is determined by how well you keep up. Play is very similar to that of Dance Aerobic Classes. Your score begins at 100 and will decrease if you make mistakes. However, if you manage to complete the next Routine correctly you can bring your score back up.



Remember, every time you hit Reset the Routines will change their order, then you can enjoy a whole new aerobic workout.



COMPLIANCE WITH FCC REGULATIONS

This equipment generates and uses radio frequency energy and if not installed and used properly, that is, in strict accordance with the manufacturer's instructions, may cause interference to radio and television reception. It has been type tested and found to comply with the limits for a Class B computing device in accordance with the specifications in Subpart J of Part 15 of FCC Rules, which are designed to provide reasonable protection against such interference in a residential installation. However, there is no guarantee that interference will not occur in a particular installation. If this equipment does cause interference to radio or television reception, which can be determined by turning the equipment off and on, the user is encouraged to try to correct the interference by one or more of the following measures:

- Reorient the receiving antenna
- Relocate the NES with respect to the receiver
- Move the NES away from the receiver
- Plug the NES into a different outlet so that Control Deck and receiver are on different circuits.

If necessary, the user should consult the dealer or an experienced radio/television technician for additional suggestions. The user may find the following booklet prepared by the Federal Communications Commission helpful:

How to Identify and Resolve Radio—TV Interference Problems.

This booklet is available from the U.S. Government Printing Office, Washington, D.C. 20402, Stock No. 004-000-00345-4.

90-DAY LIMITED WARRANTY NINTENDO GAME PAKS

90-DAY LIMITED WARRANTY:

Nintendo of America Inc. ("Nintendo") warrants to the original consumer purchaser that this Nintendo Game Pak ("PAK") shall be free from defects in material and workmanship for a period of 90 days from date of purchase. If a defect covered by this warranty occurs during this 90-day warranty period, Nintendo will repair or replace the PAK, at its option, free of charge.

To receive this warranty service:

1. DO NOT return your defective Game Pak to the retailer.
2. Notify the Nintendo Consumer Service Department of the problem requiring warranty service by calling: 1-800-422-2600. Our Consumer Service Department is in operation from 9:00 A.M. to 5:00 P.M. Pacific Time, Monday through Saturday. Please Do Not send your Pak to Nintendo before calling the Consumer Service Department.
3. If the Nintendo Service Representative is unable to solve the problem by phone, you will be provided with a Return Authorization number. Simply record this number on the outside packaging of your defective PAK, and return your PAK **FREIGHT PREPAID AND INSURED FOR LOSS OR DAMAGE**, together with your sales slip or similar proof-of-purchase within the 90-day warranty period to:

Nintendo of America Inc.
NES Consumer Service Department
4820-152th Avenue N.E.
Redmond, WA 98052

This warranty shall not apply if the PAK has been damaged by negligence, accident, unreasonable use, modification, tampering, or by other causes unrelated to defective materials or workmanship.

REPAIR/SERVICE AFTER EXPIRATION OF WARRANTY:

If the PAK develops a problem requiring service after the 90-day warranty period, you may contact the Nintendo Consumer Service Department at the phone number noted at NE. If the Nintendo Service Representative is unable to solve the problem by phone, you will be advised of the approximate cost for Nintendo to repair or replace the PAK, and will be given a Return Authorization number.

You may then record this number on the outside packaging of the defective PAK and return the defective merchandise. **FREIGHT PREPAID AND INSURED FOR LOSS OR DAMAGE** to Nintendo, and enclose a money order payable to Nintendo of America Inc. for the cost quoted you. (Payments may also be charged on a VISA or MASTERCARD credit card.)

If after personal inspection, the Nintendo Service Representative determines the PAK cannot be repaired, it will be returned and your payment refunded.

WARRANTY LIMITATIONS:

ANY APPLICABLE IMPLIED WARRANTIES, INCLUDING WARRANTIES OF MERCHANTABILITY AND FITNESS FOR A PARTICULAR PURPOSE, ARE HEREBY LIMITED TO NINETY DAYS FROM THE DATE OF PURCHASE AND ARE SUBJECT TO THE CONDITIONS SET FORTH HEREIN. IN NO EVENT SHALL NINTENDO BE LIABLE FOR CONSEQUENTIAL OR INCIDENTAL DAMAGES RESULTING FROM THE BREACH OF ANY EXPRESS OR IMPLIED WARRANTIES.

The provisions of this warranty are valid in the United States only. Some states do not allow limitations on how long an implied warranty lasts or exclusion of consequential or incidental damages, so the above limitations and exclusion may not apply to you. This warranty gives you specific legal rights, and you may also have other rights which vary from state to state.